

# Spray pyrolyzed Nanostructured Cu doped Strontium Titanate Thin Films for highly sensitive Chlorine gas sensor

Rajendrakumar Ahirrao<sup>1</sup>, Amit Chaudhari<sup>2</sup>, Madhav Wagh<sup>3</sup>

Assistant Professor, Dept. of Physics, NSS'S U. P. College Dahiwel, Maharashtra, India<sup>1</sup>

P.G. Student, Department of Civil Engineering, Late. G.M. Sapkal College of Engineering, Nashik Maharashtra, India<sup>2</sup>

Associate Professor, Dept. of Physics, Material Science laboratory, Pratap College, Amalner, Maharashtra, India<sup>3</sup>.

**ABSTRACT:** Nanostructured thin films were prepared by spray pyrolysis technique. The 0.1M Sr(Cl<sub>2</sub>)<sub>6</sub>H<sub>2</sub>O and 0.1M TiCl<sub>3</sub> were the starting precursors to fabricate SrTiO<sub>3</sub> (STO) thin films. The STO and Cu-STO nanostructured thin films were characterized by XRD, FE-SEM, and TEM spectroscopy. The TEM analysis of STO and Cu-STO thin films show the grain size of 200nm and 100nm respectively. The gas sensing performance of these films was checked on static gas sensing system for CO, H<sub>2</sub>S, LPG, C<sub>2</sub>H<sub>5</sub>OH, CO<sub>2</sub>, NH<sub>3</sub> and chlorine gases. The films were modified by doping 0.1M CuO and gas-sensing performance was getting checked for same gases. The STO and Cu-STO nanostructured films show response to chlorine gas at 350°C and 300°C respectively. The 13 sec response and 25 sec recovery time for the Cl<sub>2</sub>sensor were observed. The results and mechanism of gas sensing for chlorine gas was discussed.

**KEYWORDS:** Spray pyrolysis, doping, nanostructured films, Selectivity, Chlorine gas response, Response and recovery time

## I. INTRODUCTION

A great deal of research has been dedicated to investigating the nanoparticles, nanotubes, nanowires, nanobelts and nanorods in the detection of various gases. Gas sensors are mainly applied to detecting toxic gases, flammable gas and medical diagnosis [1]. The sensors with better performance by adopting methods like doping or dipping since changing the containment of the material may distinctly improve the adsorption/desorption characteristics. The doping of foreign elements in perovskite, such as the doping of transition metals and non-metals has been reported.

Chlorine is a yellow-green colored corrosive gas with a very sharp smell. It is extensively used in industrial processes and as biocides to destroy harmful bacteria in drinking water and other types of water such as in swimming pools and plant effluents. The rapid detection of chlorine and chlorine dioxide in the air at the maximum permissible concentrations is 1 and 0.1 mg/m<sup>3</sup> respectively. It is a toxic gas with very low toxic limit of 5 ppm in air for 8 hr. The toxic risk of chlorine is 1 STEL (short term exposure limit) and 0.5 TWA (time weighted average). The chlorine exposure at this level causes eye and mucous membrane irritation which can lead to dermatitis, tooth enamel erosion, chronic sore throat, susceptibility to tuberculosis etc. The toxicity of chlorine gas is at 0.2 ppm the odor can be noticeable, at 30 ppm coughing and vomiting, at 60 ppm lung damage, at 1000 ppm death with a few deep breaths, it is used as chemical weapon [2].

Recently, use of toxic chemical gases in manufacturing and perilously in potential terrorist activities has been on the rise, making detection of these compounds when released either intentionally or accidentally, a top security concern. A prime example of one such gas is chlorine, useful in many industrial processes and yet very harmful when released into the environment. Chlorine can be detected by gas chromatography, chemical detecting tubes and electrochemical sensing techniques. Transparent conducting oxide (TCO) thin film sensors operate at higher temperatures (~300°C). However, it is inconvenient to operate sensors at higher temperatures for monitoring. So, there

is a great demand and emerged challenges for monitoring them for the purpose of control and safety applications in domestic and industrial field. The Zirconia tubes, MgO-In<sub>2</sub>O<sub>3</sub>, ZnO-In<sub>2</sub>O<sub>3</sub>, Zn<sub>2</sub>In<sub>2</sub>O<sub>5</sub>-MgIn<sub>2</sub>O<sub>4</sub>(TCO), ZnO-CaO, ZnO, CdSnO<sub>3</sub>, WO<sub>3</sub>, CuO-CdIn<sub>2</sub>O<sub>4</sub>, etc are the materials utilized in Cl<sub>2</sub> sensing applications [3]. The multilayered STO sensors have been found high potential for lean hydrocarbon sensing [4]. It has also reported that surface additives play an important role in enhancing the gas response and specificity to particular gas. The additives like Al, In, Cu, Fe, Sn and Ru [5] are often added to improve the response and selectivity. Reports on Cl<sub>2</sub> gas sensing are much fewer [6]. With the higher requirements of sensors qualified for detecting, further studies on new semiconductor sensing materials and their practical application will be made in toxic gases detection make the topic prevalent in this area. In the present investigation, pure and CuO modified STO spray pyrolyzed nanostructured thin films are investigated for the fabrication of highly sensitive Cl<sub>2</sub> sensors.

## II. EXPERIMENTAL

### A. PRECURSOR COMPOSITION

The Sr<sub>(1-x)</sub>Ti<sub>x</sub>O<sub>3</sub> and Cu<sub>x</sub>SrTi<sub>1-x</sub>O<sub>3</sub> thin films were prepared by spraying 0.1M aqueous solution of mixture of Strontium chlorite hexahydrate (Sr(Cl<sub>2</sub>)<sub>6</sub>H<sub>2</sub>O), Titanium trichloride (TiCl<sub>3</sub>) and Cupric oxide (for doping). All solvents were completely miscible, in a volume ratio of 1:1(Sr: Ti) and 1:1:1 (Cu: Sr: Ti) ratio. Mixing the solution was carried out by using magnetic stirrer and leaving the solution for 30 minutes to make sure that no residues were left and to ensure the homogeneity of the resultant solution. The resultant solution was sprayed on preheated glass substrate. The resultant films were uniform and have good adhesive properties. The formation of STO thin films was achieved according to the following chemical reaction.

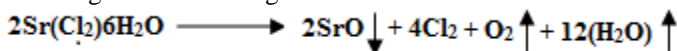

### B. SPRAY PYROLYSIS DEPOSITION OF NANOSTRUCTURED STO AND CU-STO THIN FILMS

Figure 1 shows the schematic diagram of a spray pyrolysis system. The spray pyrolysis technique has gained traction over its alternatives due to its cost effectiveness. During deposition, a gas pressure nozzle is used to atomize spray of solution. The nozzle generates very small droplets, which are directed towards the glass substrate. This is a thermally stimulated reaction between the clusters of liquid vapour atoms of different spraying solutions of the desired compound onto a substrate maintained at elevated temperature of 350°C. The sprayed droplets on reaching the hot substrate undergo pyrolytic decomposition and form a single crystal or cluster of crystallites of the product.

The steps that describe the processes taking place during spray pyrolysis deposition are [7]:

1. Atomization of the precursor solution;
2. Aerosol transport of the droplets;
3. Decomposition of the precursor to initiate film growth.

Further as prepared thin films were characterized by using characterization techniques as XRD, SEM, TEM and also to study the gas sensing properties.

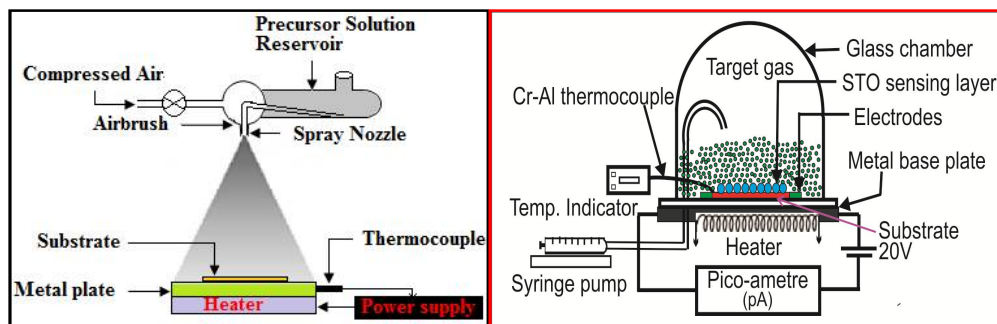

Fig.1.Spray pyrolysis system set-up. Fig.2.Experimental setup used for gas response measurements.

### III. EXPERIMENTAL RESULTS

#### A. CHARACTERIZATION OF NANOSTRUCTURED STO AND CU-STO THIN FILMS

The crystalline properties of prepared Pure STO and Cu-STO thin films were identified by X-ray diffractometer (XRD, D8 ADVANCE BRUKER axes with Cu  $K_{\alpha}$ ,  $\lambda = 0.15419$  nm with scanning rate  $4^{\circ}/\text{min}$ ) in the range of  $20-80^{\circ}$ . Phase identification was performed using the JCPDS data bank. The surface morphology of as prepared STO and Cu-STO nanostructured thin films was recorded by field emission scanning electron microscopy (FE-SEM) (JEOL JSM-6360A). Transmission electron microscopy (TEM) studies were carried out on a Hitachi model HF- 2000 electron microscope operating at 200 keV.

##### 1. XRD analysis

The XRD patterns of STO and Cu-STO thin films are shown in Fig. 2(a) and Fig. 2(b) respectively. The diffraction peaks match with the standard data of a cubic phase with a Pm3m space group, according to the, JCPDS Card N1 35-0734 as indicated. The analysis demonstrates that the reflection planes are (100), (110), (111), (200), (210), (211), (220), and (300), (310), (110) peak at ( $d = 2.761 \text{ \AA}$ ,  $2\theta = 32.06$ ) is the major peak with the highest degree of crystallinity. It is clear that the intensity of the peaks depends on concentration of the solution and its volume.

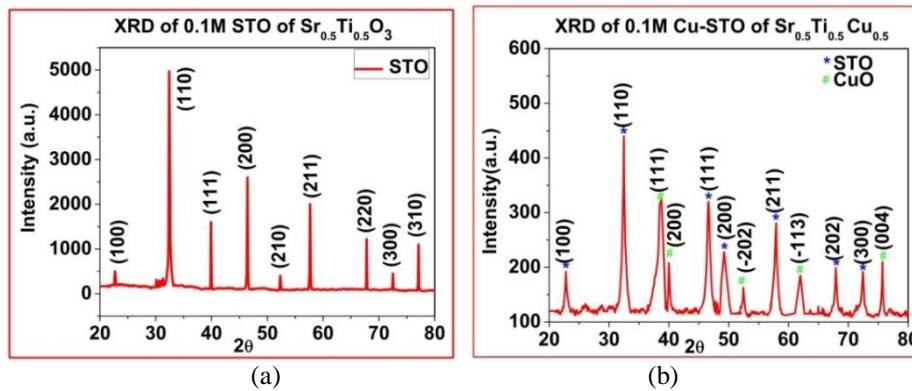

Fig.2. XRD patterns of (a) STO thin films and (b) Cu-STO thin films

##### 2. EDS spectrums

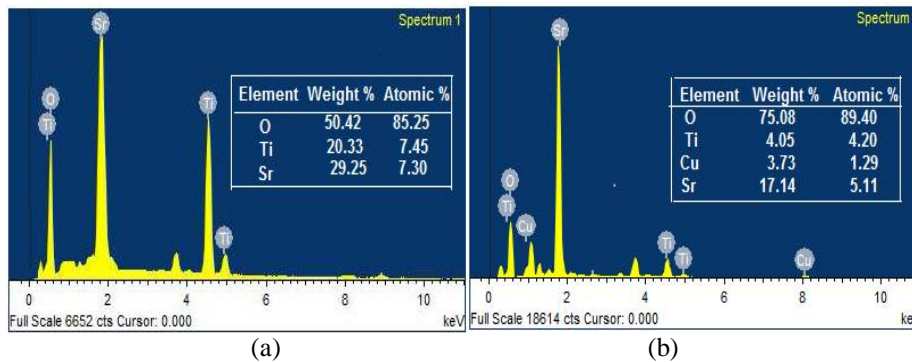

Fig.3 EDS spectrum of (a) STO and (b) Cu-STO thin films

The EDS spectrum of pure STO and Cu-STO thin films are shown in Fig. 3(a) and Fig. 3(b) respectively. From Fig.3(a), in pure STO thin films Sr, Ti, and O elements are identified and from Fig. 3(b), Sr, Ti, O and Cu elements are observed in Cu-STO thin films. The quantitative elemental analysis is with relative error observed to inset of Fig. 3(a)

and (b). The stoichiometric ratio of STO is 1:1:3 and of Cu-STO it is 1:1:3:1 which is not observed in the analysis. Therefore the films are non-stoichiometric proportion.

### 3. SEM

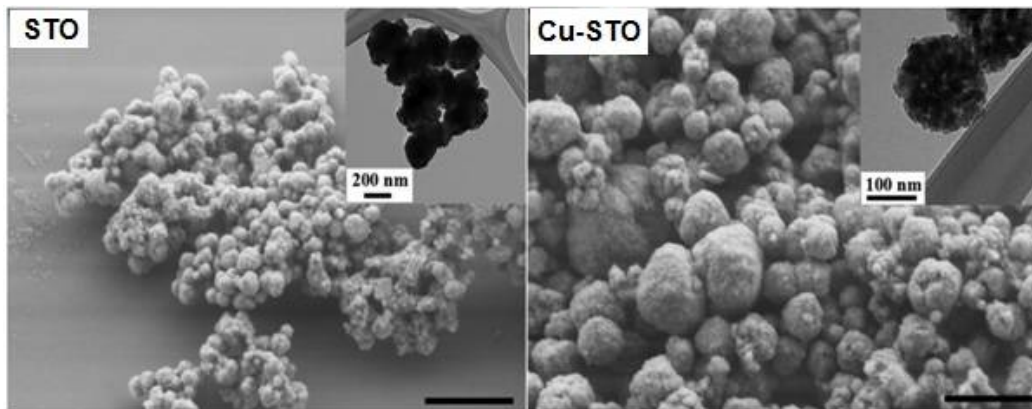

Fig. 4. The FE-SEM images of (a) STO and (b) Cu-STO with the corresponding TEM images highlighted in the insets to (a) and (b). Scale bar is 1  $\mu$ m for each FE-SEM image shown.

The sizes and morphologies of both so synthesised STO and Cu-STO motifs were investigated using TEM and FE-SEM. The STO image show micron-scale spheres, possessing average diameters of  $260 \pm 50$  nm. Analysis of the corresponding TEM image is in the inset which yield the average diameters of  $200 \pm 30$  nm, which are consistent with the FE-SEM data. From both electron microscopy images, it is clear that the external surfaces of the micron-scale spheres appear to be slightly roughened. The Cu-STO micrograph confirms the formation of porous micron-scale spheres with average diameters of  $200 \pm 30$  nm. The TEM image in the inset gives similar morphologies and has average diameters of  $100 \pm 40$  nm. From these images, it is apparent that the resulting porous micron-scale spheres likely are composed of high surface area aggregates, characterized by smaller constituent nanoparticulate.

#### **C. ADVANTAGES OF NANO-CRYSTALLINE PARTICLES IN GAS SENSING PROPERTIES**

Nanostructured materials are attractive in the field of metal oxide gas sensors to improve their performance and to produce highly sensitive sensors [8]. In nanostructured thin films the physical and chemical properties could be different from that of the bulk materials. A gas sensing phenomenon is based on the interaction of gas species with available and active site. Increasing in the theoretical surface area increases the probability of gas/solid interaction in the solid surface. This phenomenon can directly affect and improve the gas sensor sensitivity [9]. Oxygen is adsorbed on the surface of the metal oxide gas sensor, resulting in a creation of electron depleted surface region. This region has specific value at a given temperature. The depleted layer represents a barrier to electrical conduction between the solid grains. For most conventional metal oxide sensing materials, the grain size is greater than the depth of the space charge region. It means that total electrical conduction within the bulk is governed by the grain boundaries as schematized in Fig.5. In nanocrystalline metal oxides, the depth of depletion layer can be comparable to the particle size. Under this condition, grains conduction can effectively control the overall conductivity of the sensing film. It means that the overall conductivity of sensing film can be affected by very low concentration of gas. Decrease in particle size can therefore directly increase the sensitivity.

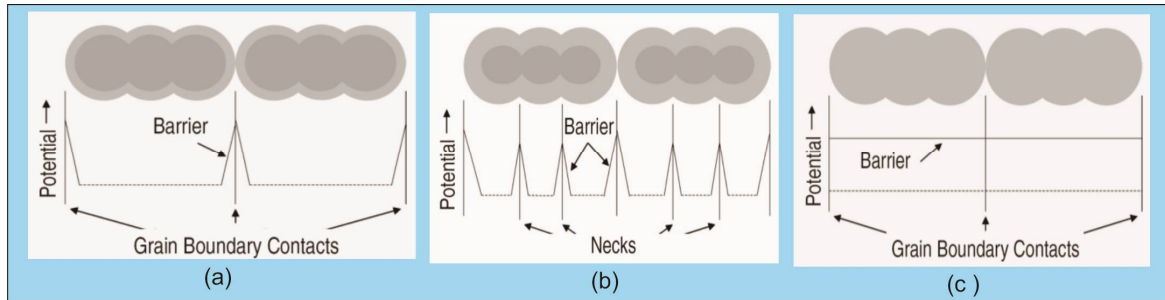

Fig.5. A model of the variation in potential barrier as a function of changes in the crystallite size. (a)  $D \gg 2L$ , (b)  $D \geq 2L$ , and (c)  $D < 2L$ , where  $D$  = crystallite size and  $L$  = depleted layer thickness. In fig. 5 a–c, the potential barrier is mainly controlled by the grain-boundaries, the necks, and the grains, respectively.  $D$ . Gas sensing properties

Gas response ( $S$ ) of the sensor is defined as the ratio of change in conductance to the conductance of the sensor on exposure of target gas.

$$S = \frac{G_g - G_a}{G_a}$$

Where,  $G_a$  = the conductance of the sensor in air  $G_g$  = the conductance on exposure of a target gas.

The gas response of the pure STO and Cu-STO thin films were determined at various operating temperatures ranging from 250°C to 450°C as shown in Fig. 6 and Fig. 7 respectively.

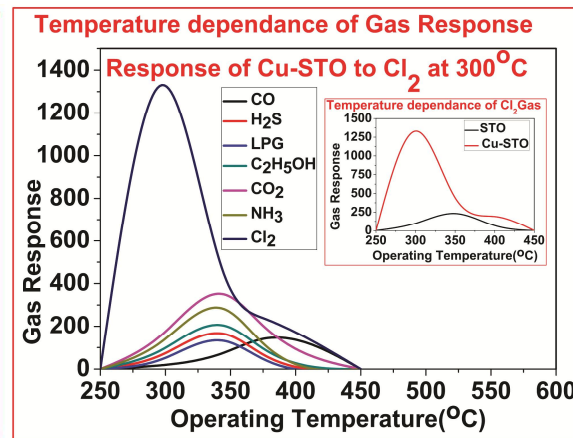
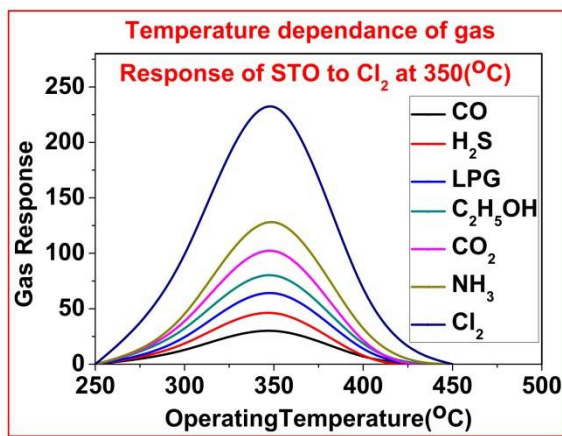

Fig.6. Response of STO to various gases Fig.7. Response of Cu-STO to various gases

Fig. 7 the inset figure shows variation of  $Cl_2$  gas response (for 1000 ppm) of STO and CuO modified STO. Among the copper oxides, only cupric oxide (CuO) phase is gas sensitive. It is clear that response of modified film goes on increasing with increasing operating temperature, attains its maximum 300°C and then decreases with further increase in operating temperature. CuO modified STO was observed to be very high (1331) at lower operating temperature (300°C) as compared to pure STO (response of 232 at 350°C). This ultra large response could be attributed to high surface reactivity due to Cu misfits on modified films. It is clear from Fig.7 that  $Cl_2$  response is very high as compared the responses of other gases. Therefore  $Cl_2$  is highly selective against ethanol,  $H_2S$ ,  $CO_2$ ,  $H_2$ , LPG and  $NH_3$ .

### E. SELECTIVITY PROFILE OF CU-STO NANOSTRUCTURED THIN FILMS

Selectivity can be defined as the ability of a sensor to respond to a certain gas in the presence of different gases. Fig. 8 shows the histogram for comparison of the  $Cl_2$  response to various gases for Cu-STO nanostructured thin films at the optimum operating temperature 300 °C. It is clear that the Cu-STO nanostructured film is highly selective to  $Cl_2$  (1000 ppm) against all other tested gases: CO,  $H_2S$ , LPG,  $C_2H_5OH$ ,  $CO_2$ ,  $NH_3$ . The inset figure shows the CuO-activated STO samples, the response values are observed to increase continuously with increasing gas concentration up to 1000 ppm.

The rate of increase in response is relatively larger up to 1000 ppm and saturates beyond 1000 ppm. Thus, the active region of the sensor would be up to 1000 ppm. At lower gas concentrations, the unimolecular layer of gas molecules would be formed on the surface of the sensor, which could interact more actively giving larger response. The multilayer's of gas molecule, on the sensor surface, at the higher gas concentrations would result into saturation in response beyond 1000 ppm gas

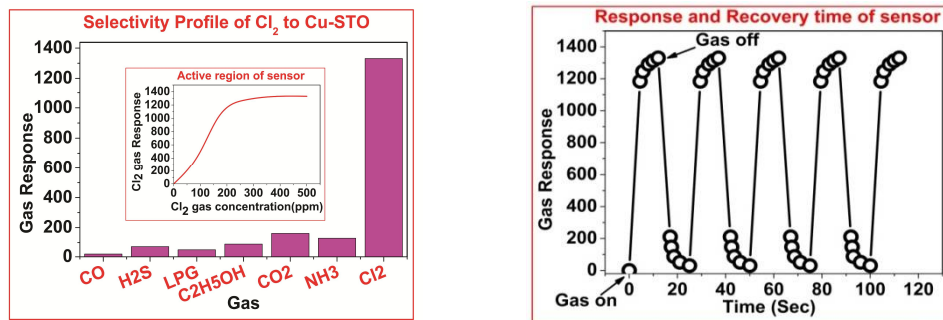

Fig.8.Selectivity profile of Cu-STO nanostructured thin films Fig. 9.Warm up time, Response/recovery time of sensor

#### F. WARM-UP, RESPONSE/RECOVERY TIME

The time required to reach the operating condition is called the warm-up time of a sensor material. The target gas is allowed to fall on the sensor element. The average gas response of 1331, average response time of 13 seconds and average recovery time (corresponding to complete or 80% recovery) of 25 seconds are noted. The time for 80% recovery was however, less than 25 seconds and beyond this time, the sensor can be considered to be ready for the next sensing cycle. The stabilization of the sensor response results from the equilibration of the chemisorption process. The most stable species at 350 °C is the O species and the stabilization was achieved when an equilibrium concentration of these adsorbed species was obtained. As response and recovery time determine the speed of response, attention has to be paid to the reaction of the gas on the sensor surface and the diffusion of the oxygen defects in the film. The decrease in the response time may possible due to CuO modification of STO film. It might influence the bulk diffusion of the oxygen defects in the film.

#### G. CHLORINE GAS SENSING MECHANISM

Chlorine molecules are adsorbed on the Cu-STO surface as negatively charged ions, trapping electrons from Cu-STO. When introducing Cl<sub>2</sub> gas, chlorine molecules adsorbed on the Cu-STO surface should also trap electrons owing to the strong electronegativity of the chlorine atom. Thus, chlorine and oxygen are competitively adsorbed on the Cu-STO surface. With the increase in temperature, the adsorbed oxygen molecules begin to desorb from the Cu-STO surface, and chlorine molecules are adsorbed dissociatively, as shown in the following equation.

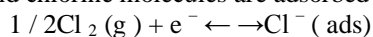

The electron comes from Cu-STO, which is consumed in the reaction, reducing the extent of the decrease in the conductivity of Cu-STO. Because the sensing mechanism is related to adsorption, the condition of the surface is, therefore, an important factor. Particles with a small grain size and a regular surface are good for enhancing sensitivity.

#### H. BAND STRUCTURE EXPLANATION OF STO AND CU-STO THIN FILMS

According to the classical theories, we propose a mechanism of physisorption and electron transfer based on energy band theory to explain the gas sensing mechanism. STO is most promising material for application in electronics [10], it is indirect band gap semiconducting material. A presumable model of energy bands of STO and CuO depicted in Fig. 10. The conduction band minimum and valance band maximum located at X and Γ points respectively. The conduction and valance bands are mainly composed of empty Ti 3d level and fully occupied O2P level respectively. Although both STO [11-12] and CuO are p-type semiconductors (In case of metal deficient phase (or oxygen excess phase) generation of acceptor metal vacancies-hence, holes-occurs and substance (CuO) has p-type of intrinsic conductivity) their band-

gaps are near about same and differ in Fermi level ( $E_F$ ); when co-working, the Fermi level of both will recombine (using a band-bending model) and ultimately reach the same level. The recombination must strengthen the mobilization of charges between STO and CuO molecules, leading to the redistribution of the charges. Finally, the redistribution of charges and recombination are more likely to change the band-gap and ability of absorbing charges. In the beginning, we assume that the  $Cl_2$  molecules absorb only at the air/film interface, and then the formation of charge transfer complexes by coordination of  $Cl_2$  to the films at the air/Cu-STO interface gives rise to appearance of the electron and hole charge carriers.

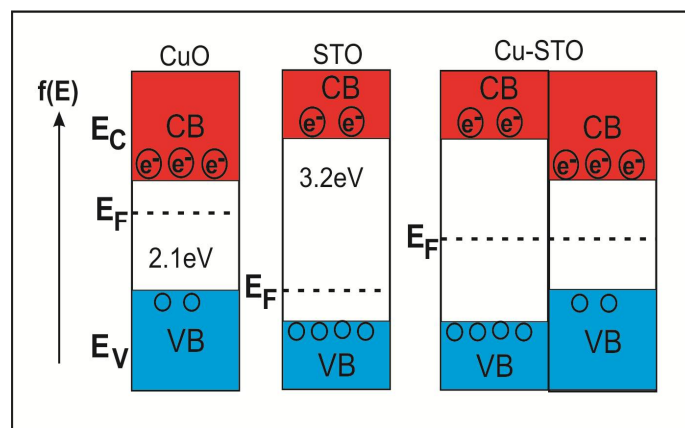

Fig.10. Presumable energy bands of CuO, STO and composite.

Some of these charge carriers will be mobilized across the forbidden gap providing that the energy of these carriers is enough to compensate for band-gap, which brings a shift to the resistance (conductivity) of the sensors. This often happens in the response period, and the recovery is quite the opposite. If this assumption is correct, then it will provide at least a qualitative understanding of the fundamental phenomena in Cu-STO semiconductors.

#### IV. CONCLUSION

Following conclusions can be made to summarize the results.

1. The STO and Cu-STO nanostructured thin films are successfully synthesized by spray pyrolysis technique.
2. The X-ray diffraction peaks of pure STO thin films match with the standard data of a cubic phase with a Pm3m space group, according to the, JCPDS Card N1 35-0734 as indicated.
3. The STO image shows micron-scale spheres, possessing average diameters of  $260 \pm 50$  nm.
4. Pure STO gives poor response to  $Cl_2$  gas at  $350^\circ C$  as compared to other gases.
5. Cu-STO thin film gives gas response 1331 at operating temperature  $300^\circ C$ .
6. CuO doping and nanostructured nature was observed to be good promoter in gas sensing performance of STO based gas sensors.

#### REFERENCES

- [1] A. Criminisi, X.Y. Feng, J. Jiang, Ding, H. Ding, R.M. Luo, X. Huang., "Carbon-assisted synthesis of mesoporous  $SnO_2$  nanomaterial as highly sensitive ethanol gas sensor" Sens. ActuatorsB, 183, 526-534, 2013.
- [2] Maynard king, "clean and safe drinking water workshop", 2011.
- [3] M.S. Wagh, L.A. Patil, T. Seth, D.P. Amalnerkar "Surface cupricated  $SnO_2-ZnO$  thick film as  $H_2S$  gas sensors" Mater. Chem. Phys. 84, 228-233, 2004.
- [4] M.S. Wagh, G.H. Jain, D.R. Patil, S.A. Patil, L.A. Patil, "Modified zinc oxide thick film resistors as  $NH_3$  gas sensors" Sens. Actuators B 115,128-133,2006.
- [5] F. Paraguay, M. Yoshida, J. Morales, J. Solis, W. Estrada, "Influence of Al, In, Cu, Fe, and Sn dopants on the response of thin film ZnO gas sensors to ethanol vapor" Thin Solid films, 373, 137-140, 2000
- [6] X.F. Chu, "High sensitivity chlorine gas sensors using  $CdIn_2O_4$  thick film prepared by co-operation method" Mater. Res. Bull. 38, 1705-1711, 2003.

**International Journal of Innovative Research in Science, Engineering and Technology**

*An ISO 3297: 2007 Certified Organization*

*Volume 6, Special Issue 1, January 2017*

**International Conference on Recent Trends in Engineering and Science (ICRTES 2017)**

**20<sup>th</sup>-21<sup>st</sup> January 2017**

**Organized by**

**Research Development Cell, Government College of Engineering, Jalagon (M. S), India**

- [7] D. Perednis, L. Gauckler, "Solid oxide fuel cells with electrolytes prepared via spray pyrolysis" Solid State Ion., 166, 229–239, 2004.
- [8] S. Seal, S. Shukla, "Nanocrystalline SnO<sub>2</sub> gas sensors in view of surface reactions and modifications" Journal of the Minerals, Metals and Materials Society, 54, 35-38, 2002.
- [9] G.Q. Lu, X.S. Zhao, "Nanoporous materials: science and engineering" Imperial College Press, 2004.
- [10] S.Y. Yang, J. Seidel, S.J. Byrnes, P. Shafer, C.H. Yang, M.D. Rossell, P. Yu, Y.H. Chu, J.E. Scott, J.W. Ager, L.W. Martin, R. Ramesh, Naf. Nanotech. 5, 143, 2010.
- [11] T. Higuchi and T. Tsukamoto, N. Sata and M. Ishigame, Y. Tezuka and S. Shin, "Electronic structure of p-type SrTiO<sub>3</sub> by photoemission spectroscopy" Physical Review B, 57, 12, 1998.
- [12] D.H. Dawson, D.E. Williams, "Gas sensitive resistors: surface interaction of chlorine with semiconducting oxides" J. Mater. Chem. 6 (3), 409-414, 1996.